

**SIGSAUER®**

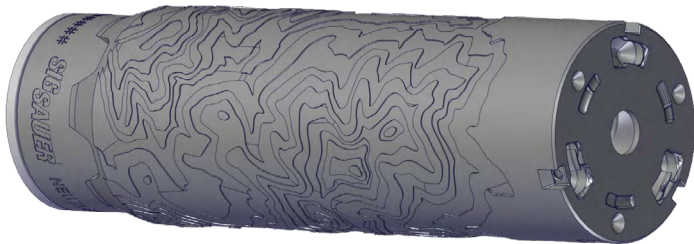

# ***SIG BOLT RIFLE SUPPRESSORS***

***OPERATOR'S MANUAL: HANDLING & SAFETY INSTRUCTIONS***



READ THE INSTRUCTIONS AND WARNINGS IN THIS MANUAL CAREFULLY BEFORE USING THIS SUPPRESSOR.



# WARNINGS



# WARNINGS

**SIGSAUER**



## WARNING

**BEFORE OPERATING THE FIREARM, REVIEW THE SAFETY WARNINGS MANUAL THAT WAS PROVIDED WITH THE FIREARM. ALTERNATIVELY, REFER TO SIGSAUER.COM FOR THE LATEST SAFETY WARNING INFORMATION.**

For more information, scan the QR code below to visit [sigsauer.com](https://sigsauer.com).





# WARNINGS

## 1.0 SAFETY WARNINGS

### READ THIS ENTIRE MANUAL THOROUGHLY AND CAREFULLY PRIOR TO USING THIS SUPPRESSOR WITH YOUR FIREARM.

SIG SAUER, INC.<sup>®</sup> firearms and accessories are designed to function reliably with proper care and knowledgeable use. Operators must understand the safe operation and use of any firearm equipped with a SIG SAUER suppressor. Read and follow these instructions carefully. Do not use a firearm with this suppressor without understanding the instructions outlined in this manual and the safe operation of the firearm. **Failure to follow the instructions outlined in the host firearm manual and in this manual may result in serious injury or death to the operator and/or others. Damage to the suppressor, host firearm, and other property may also occur.**

The warnings in this Operator's Manual are extremely important. By understanding the dangers inherent in the use of any firearm, and by taking the precautions described in this manual, you can experience a high level of safety in the use of your suppressor. Failure to heed any of these warnings may result in serious injury or death to you or others, as well as severe damage to the firearm or other property.



# WARNINGS

**SIG SAUER**

**WARNINGS** in this manual identify a clear danger to the person performing that procedure. Warnings are identified by a red banner with the word **WARNING** in white, bold, uppercase letters and a **WARNING** icon. Failure to comply with a **WARNING** can result in serious injury or death to you or a bystander.



## WARNING

**CAUTIONS** in this manual identify a risk of damage to the suppressor or firearm being maintained. **CAUTIONS** are identified by a black banner with the word **CAUTION** in white, bold, uppercase letters.

## CAUTION



# WARNINGS

## 1.1 ALTERATIONS

This SIG SAUER suppressor was designed to function properly in its original condition. Unauthorized alterations can make it unsafe, and many alterations are illegal and carry severe penalties under federal law. Do not alter any part or add or substitute any parts of this suppressor. Do not add any substance such as water, oil, grease, or wire pulling gel into the suppressor.

## 1.2 BATFE WARNING

All NFA rules and regulations apply to this suppressor. It is unlawful to change the overall length of this suppressor by adding baffles or any other component that would increase the overall length of the suppressor beyond the original length as shipped from SIG SAUER.

## 1.3 HOT SURFACE

Never touch the suppressor when hot. Failure to comply may result in severe burns to unprotected skin. Seek immediate medical attention if injury occurs.

## 1.4 TRANSPORTING

Suppressors are not legal in all jurisdictions. It is the responsibility of the operator to know the laws of different states and jurisdictions when traveling with a suppressor in their possession.



# WARNINGS

**SIG SAUER**

## 1.5 LIABILITY

**This product is classified as a suppressor and is sold by SIG SAUER with the specific understanding that SIG SAUER shall not be responsible in any manner whatsoever for malfunctioning of the suppressor or host firearm, physical injury, or property damage resulting in whole or in part from:**

- **Criminal or negligent discharge**
- **Improper, careless, or abusive handling**
- **Unauthorized modifications or parts replacement**
- **Defective, improper, hand-loaded, or reloaded ammunition**
- **Corrosion**
- **Neglect**
- **Other influences beyond our direct and immediate control**

**This limitation applies regardless of whether liability is asserted on the basis of contract, negligence, or strict liability (including any failure to warn). Under no circumstance shall SIG SAUER, Inc. be liable for incidental or consequential damages, such as loss of use of property, commercial loss, and loss of earnings or profits.**



# WARNINGS

## 1.6 THE BASIC RULES OF SAFE FIREARMS HANDLING

- ALWAYS treat every firearm as if it were loaded.
- ONLY load a round in the chamber when ready to fire.
- NEVER pull the trigger or place fingers on the trigger or in the trigger guard until ready to fire.
- NEVER allow clothing or other foreign objects to interfere or come in contact with the trigger.
- ALWAYS carry a pistol in a holster specifically designed for that pistol. It is the responsibility of the customer to ensure the holster is compatible with their specific pistol and any installed accessories.
- ALWAYS be sure the barrel is clear of any obstruction.
- ALWAYS be aware of the surroundings, and the safety of bystanders before shooting. Know the target and what is in front of and beyond it.
- ALWAYS use clean, dry, original factory-made ammunition of the proper type and caliber for the firearm.
- ALWAYS wear ear protection and safety glasses when shooting.
- ALWAYS carry a firearm so that control of the muzzle can be maintained in the event of a fall or stumble.
- NEVER shoot at a flat surface or water.
- DO NOT leave a loaded firearm unattended. Only store a firearm that is unloaded, cleared of all ammunition, and locked in a secure place inaccessible to children or unauthorized persons.



# WARNINGS

**SIG SAUER**

- NEVER allow the firearm to be used by anyone who has not read and understood the Operator's Manual.
- ALWAYS unload and clear a firearm according to the instructions in the Operator's Manual before handing it to another person.
- DO NOT point any firearm, loaded or unloaded, at any undesignated or unsafe target.
- NEVER discharge a firearm near an animal unless the animal is trained to accept the noise. An animal's startled reaction could injure it or cause an accident.
- NEVER drink alcoholic beverages or use drugs before or during shooting, as vision and judgment could be seriously impaired, making firearm handling unsafe.
- ALWAYS seek a doctor's advice before using a firearm if using medication that would impair judgment or usage.

## 1.7 EYE AND EAR PROTECTION



Always wear safety glasses that meet the requirements of American National Standards Institute (ANSI) z87.1 or European Standard (EN)166:2001 and ear plugs and "earmuff" type protectors whenever shooting. Always make certain that persons close are similarly protected. Unprotected eyes may be injured by powder, gas, carbon residue, lubricant, metallic particles, or similar debris that may emanate occasionally from any firearm in normal use. Without ear protection, repeated exposure to shooting noise may lead to cumulative, permanent hearing loss.

Installing a suppressor does not replace ear protection. Suppressors may not lower the shooting noise enough to prevent hearing damage.



# WARNINGS

## 1.8 AMMUNITION

Use only high-quality, original, factory-manufactured ammunition. Do not use cartridges that are dirty, wet, corroded, bent, or damaged. A damaged or deformed cartridge may impede chambering or cause the cartridge case to burst upon firing. Do not oil cartridges. Lubricant or other foreign matter on cartridges can potentially cause dangerous ammunition malfunctions. Some highly penetrative lubricants can also migrate inside cartridge cases and cause deterioration of the propellant powder; on firing, the powder might not ignite. If only the primer ignites, there is danger that the bullet may become lodged in the barrel. Only use ammunition of the caliber for which the firearm is chambered.

The use of reloaded, “re-manufactured”, hand-loaded, or other nonstandard ammunition voids all warranties. Reloading is a science, and improperly loaded ammunition can cause severe damage to the suppressor and host firearm and serious injury to the shooter or to others may result. Always use ammunition that complies with the industry performance standards established by the Sporting Arms and Ammunition Manufacturers’ Institute, Inc.(SAAMI) or ammunition manufactured to U.S. military specifications.

SIG SAUER, Inc., specifically disclaims responsibility for any damage or injury whatsoever occurring in connection with, or as a result of, the use with any SIG SAUER suppressor of faulty, non-standard, “re-manufactured”, hand-loaded (reloaded) ammunition, or cartridges other than those for which the suppressor was originally manufactured. Excessive pressure inside the chamber or barrel while firing a firearm may cause severe damage and serious injury or death to the shooter or to others may occur.



# WARNINGS



Do not fire non-jacketed, pre-fragmented (frangible), multi-projectile, tracer, or shot cartridges through SIG SAUER pistol or rifle suppressors. Firing anything but jacketed projectiles manufactured to SAAMI specification through centerfire suppressors may result in a fragment hazard and/or damage to the suppressor and/or host firearm.



**WARNING: CANCER AND REPRODUCTIVE HARM—[www.P65warnings.ca.gov](http://www.P65warnings.ca.gov)**



DISCHARGING FIREARMS IN POORLY VENTILATED AREAS, CLEANING FIREARMS, OR HANDLING AMMUNITION MAY RESULT IN EXPOSURE TO LEAD AND OTHER SUBSTANCES KNOWN TO THE STATE OF CALIFORNIA TO CAUSE BIRTH DEFECTS, REPRODUCTIVE HARM, AND OTHER SERIOUS PHYSICAL INJURY. MAINTAIN ADEQUATE VENTILATION AT ALL TIMES. WASH HANDS THOROUGHLY AFTER EXPOSURE. SHOOTING OR CLEANING FIREARMS MAY EXPOSE OPERATORS TO LEAD.



# WARNINGS

## 1.9 BAFFLE STRIKE

A sudden degradation in accuracy or the appearance of a tumbled bullet impact on target may indicate a baffle or end cap strike.

If you suspect the suppressor has suffered a baffle or end cap strike immediately stop shooting, clear and unload the firearm:

- Inspect the suppressor for tightness to the barrel.
- Inspect the end cap for evidence of a strike.
- Inspect the suppressor body for any indication of internal damage.

If there is damage or suspected damage contact customer service for repair. Serious injury or death, and damage can result from shooting a suppressor with a known baffle strike. Always wear shooting glasses and hearing protectors. Improper ammunition destroys firearms.

## CONTENTS

1.0 SAFETY WARNINGS . . . . .	4
1.1 ALTERATIONS . . . . .	6
1.2 BATFE WARNING . . . . .	6
1.3 HOT SURFACE . . . . .	6
1.4 TRANSPORTING . . . . .	6
1.5 LIABILITY . . . . .	7
1.6 THE BASIC RULES OF SAFE FIREARMS HANDLING . . . . .	8
1.7 EYE AND EAR PROTECTION . . . . .	9
1.8 AMMUNITION . . . . .	10
1.9 BAFFLE STRIKE . . . . .	12
2.0 SPECIFICATIONS . . . . .	14
2.1 FEATURES . . . . .	15
2.1.1 ENDURE SUPPRESSOR . . . . .	15
2.1.2 TIN CAN SUPPRESSOR . . . . .	16
3.0 PREPARATIONS FOR USE . . . . .	17
3.1 ATTACHING SUPPRESSOR . . . . .	17
3.2 OPERATING WITH A SUPPRESSOR INSTALLED . . . . .	21
4.0 REMOVING SUPPRESSOR FROM FIREARM . . . . .	23
5.0 MAINTENANCE . . . . .	25
5.1 CLEANING . . . . .	25
5.2 INSPECTION . . . . .	26
6.0 CHANGING HUB TAPERED MOUNT . . . . .	27
6.1 REMOVAL . . . . .	27
6.2 INSTALLATION . . . . .	29
SIG SAUER INFINITE GUARANTEE™ . . . . .	31

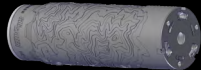

## 2.0 SPECIFICATIONS

The ENDURE™ and TiN CAN™ rifle suppressors are lightweight suppressors designed for bolt action rifles and rated for common .30 caliber ammunition. Both suppressors are built to be compatible with industry standard HUB mounting systems and function with both the standard HUB and HUB tapered mounts.

To ensure best performance and compatibility, SIG SAUER recommends use only on bolt action rifles.

Additional information about SIG SAUER products, SIG SAUER Academy and the SIG Experience Center, Special Programs, and additional support can be found by scanning the QR code below to visit [sigsauer.com](http://sigsauer.com).



## 2.1 FEATURES

### 2.1.1 ENDURE SUPPRESSOR

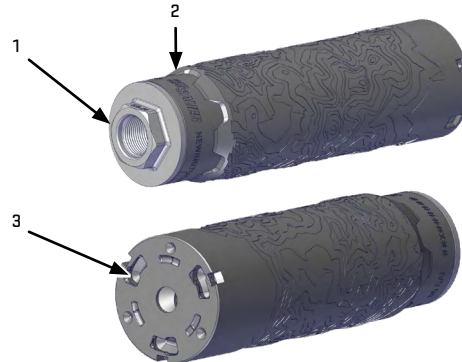

NUMBER	NOMENCLATURE
1	HUB Tapered Mount
2	Suppressor Body
3	Suppressor Accessory Attachment Point

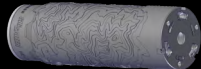

## 2.1.2 TIN CAN SUPPRESSOR

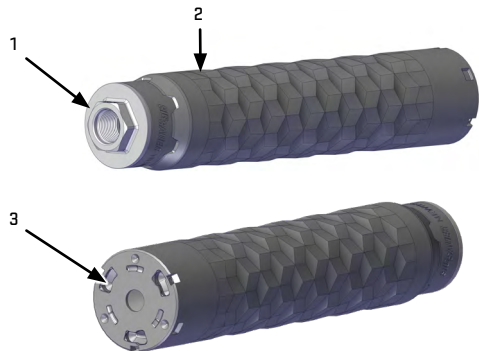

NUMBER	NOMENCLATURE
1	HUB Tapered Mount
2	Suppressor Body
3	Suppressor Accessory Attachment Point

## 3.0 PREPARATIONS FOR USE

### 3.1 ATTACHING SUPPRESSOR



**WARNING UNLOAD/CLEAR**



ALWAYS ENSURE THE FIREARM IS UNLOADED AND CLEARED BY VISUALLY AND PHYSICALLY INSPECTING THE CHAMBER PRIOR TO INSTALLING, TIGHTENING, OR REMOVING A SUPPRESSOR. FAILURE TO DO SO MAY RESULT IN SERIOUS INJURY, DEATH, AND/OR DAMAGE TO THE SUPPRESSOR AND FIREARM. REFER TO THE OPERATOR'S MANUAL FOR THE PARTICULAR HOST FIREARM.



**WARNING INSTALLATION**



DISCHARGING A FIREARM WITH AN IMPROPERLY INSTALLED SUPPRESSOR CAN RESULT IN SERIOUS INJURY OR DEATH AND DAMAGE TO THE SUPPRESSOR AND FIREARM.

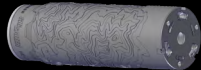

## WARNING INSTALLATION



**THIS SUPPRESSOR MUST BE INSTALLED ON A BARREL WITH A 90 DEGREE SHOULDER. IF INSTALLING ON A BARREL WITH A TAPERED SHOULDER, INSTALL A TAPER CAP BEFORE INSTALLING THE SUPPRESSOR. FAILURE TO DO SO MAY RESULT IN SERIOUS INJURY, DEATH, AND/OR DAMAGE TO THE SUPPRESSOR AND HOST FIREARM.**

1. Ensure the threads of both the muzzle and suppressor are clean.
2. If necessary, install a taper cap on the barrel. Do not install the suppressor on a tapered barrel without a taper cap.



90 DEGREE SHOULDER

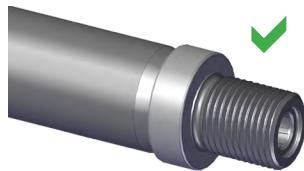

TAPER CAP



TAPERED BARREL

## CAUTION

WHEN INSTALLING A SIG SAUER BOLT ACTION RIFLE SUPPRESSOR, ALWAYS ENSURE THAT THE RIFLE'S MUZZLE DEVICE DOES NOT CONTACT THE SUPPRESSOR BAFFLES. DO NOT INSTALL THIS SUPPRESSOR TO AN INCOMPATIBLE MUZZLE DEVICE. FAILURE TO COMPLY MAY DAMAGE THE SUPPRESSOR AND/OR THE HOST FIREARM.

SIG SAUER recommends attaching the HUB mount directly to the barrel. Aftermarket HUB compatible muzzle devices may protrude past the HUB mount and contact the baffle.

Measurements below start at the flange of the HUB mount. When measuring muzzle devices, measure from the flange of the HUB mount to the end of the muzzle device.

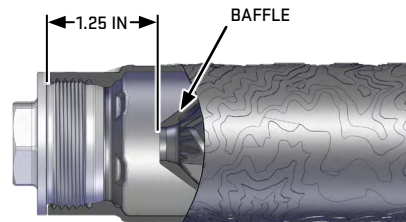
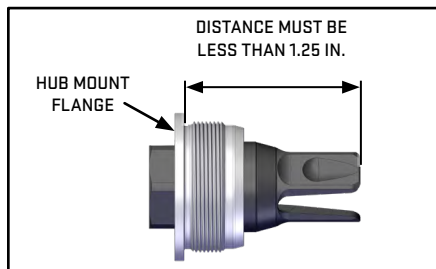

\*ENDURE pictured as example

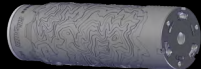

3. Thread suppressor clockwise onto barrel by hand.
4. Using a 7/8-in. crow's foot wrench and a torque wrench handle, tighten the suppressor to 25-27 ft-lbf or to the rifle manufacturer's recommended torque value.

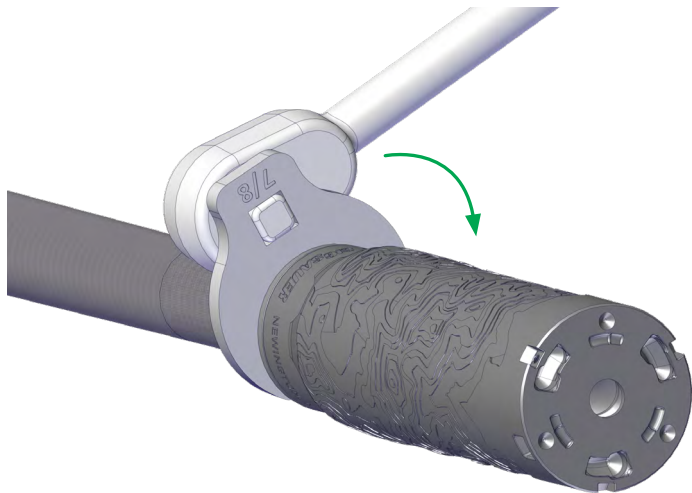

### 3.2 OPERATING WITH A SUPPRESSOR INSTALLED



#### WARNING AMMUNITION



DO NOT FIRE NON-JACKETED, PRE-FRAGMENTED (FRANGIBLE), TRACER, MULTI-PROJECTILE, OR SHOT CARTRIDGES THROUGH SIG CENTERFIRE SUPPRESSORS. FIRING ANYTHING BUT JACKETED PROJECTILES MANUFACTURED TO SAAMI SPECIFICATION THROUGH CENTERFIRE SUPPRESSORS MAY RESULT IN A FRAGMENT HAZARD AND/OR DAMAGE TO THE SUPPRESSOR AND/OR FIREARM.



#### WARNING OBSTRUCTED SUPPRESSOR



DO NOT FIRE AMMUNITION THROUGH A SUPPRESSOR WITH ANY OBSTRUCTIONS, SUCH AS WATER, DEBRIS, OR FOREIGN MATERIALS. FAILURE TO COMPLY MAY RESULT IN DEATH, SERIOUS INJURY, AND DAMAGE TO THE SUPPRESSOR AND/OR FIREARM.



#### WARNING OVERHEATING



DO NOT CONTINUE TO FIRE AMMUNITION THROUGH AN OVERHEATED SUPPRESSOR. THIS CAN RESULT IN FAILURE OF THE SUPPRESSOR, ACCOMPANIED BY FRAGMENT AND HOT GAS HAZARDS. SERIOUS INJURY AND/OR DAMAGE TO THE SUPPRESSOR AND FIREARM CAN OCCUR.

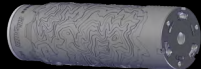

- A. SIG SAUER recommends firing jacketed, subsonic ammunition through the suppressor when available. The service life of the suppressor is directly related to the firing schedule it is subjected to. Overheating the suppressor will shorten its service life and, in extreme cases, may result in immediate damage.
- B. Firing supersonic ammunition through the suppressor will accelerate the rate of heat buildup compared to subsonic ammunition. Discoloration of the suppressor baffles is an indication of excessive heat buildup.
- C. Do not pour water, abrasives, or any other liquid into the suppressor baffles and fire. This will damage and cause accelerated wear to the suppressor, significantly reducing its service life.
- D. During use, periodically check to ensure the suppressor remains securely threaded to the firearm.
- E. If the suppressor is dropped or struck, immediately inspect the suppressor for damage and ensure it is properly aligned with the barrel.
- F. Due to the properties of titanium, suppressors constructed from this material may produce visible sparks during firing. This is caused by the high pressure propellant gas contacting the internal surfaces of the suppressor and stripping off small titanium particles. Sparking is a normal and expected characteristic of titanium suppressors and may decrease with continued use. The visibility of sparks can vary depending on several factors, including barrel length, ammunition type, and shooting conditions. This phenomenon is inherent to titanium suppressors and does not indicate a defect or performance issue.

#### 4.0 REMOVING SUPPRESSOR FROM FIREARM



**WARNING HOT SURFACE**



**NEVER TOUCH SUPPRESSOR WHEN HOT. FAILURE TO COMPLY MAY RESULT IN SEVERE BURNS TO UNPROTECTED SKIN. SEEK IMMEDIATE MEDICAL ATTENTION IF INJURY OCCURS.**

#### **CAUTION**

AS CARBON BUILDS UP BETWEEN THE SUPPRESSOR AND THE MUZZLE, IT WILL BECOME PROGRESSIVELY MORE DIFFICULT TO REMOVE THE SUPPRESSOR. IF THIS OCCURS, INCREASE THE FREQUENCY OF CLEANING THE BASE.

1. Using a 7/8-in. wrench, loosen the suppressor until it can be turned by hand.

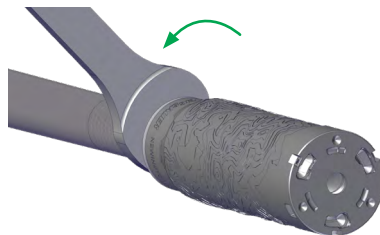

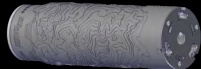

2. Continue to unscrew the suppressor from the barrel until it can be removed.



## 5.0 MAINTENANCE

### 5.1 CLEANING



**WARNING CLEANING**



**READ AND FOLLOW THE MANUFACTURER'S WARNINGS BEFORE USING SOLVENTS OR CLEANERS. USE IN A WELL-VENTILATED AREA. WEAR EYE PROTECTION.**

### CAUTION

DO NOT USE A STEEL WIRE BRUSH AS IT CAN DAMAGE THE CERAKOTE FINISH OF THE SUPPRESSOR. USE A NYLON BRUSH FOR REMOVING CARBON BUILDUP. SOLVENTS CAN BE HARMFUL TO THE SURFACE FINISH. AVOID OVER-LUBRICATION OF COMPONENTS.

#### MATERIALS REQUIRED

- Clean cloth
- Nylon brush
- CLP (Cleaner, Lubricant, Preservative)
- Dry cleaning solvent

The following instructions are for normal environmental conditions. The rate of residue buildup varies depending on the ammunition fired through the suppressor. Clean and lube at a minimum of every 500 cartridges.

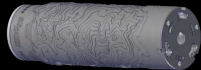

## NOTE

ENDURE and TINCAN suppressors do not require any internal cleaning.

1. Clean the suppressor threads of any residue buildup.
2. Wipe the suppressor body with a rag moistened with CLP to remove any residue. Wipe the body dry.
3. Clean any residue buildup from the rifle's muzzle threads with a brush and a dry cleaning solvent similar to (MIL-P-D-680). **Do not use CLP or any other lubricant on the barrel threads.**

## 5.2 INSPECTION

1. Inspect the rifle's muzzle threads (1) and the HUB mount threads (2) for damage.
2. Inspect the suppressor body (3) for damage.
3. Ensure the HUB mount (4) is secure in the suppressor body.



## 6.0 CHANGING HUB TAPERED MOUNT

### 6.1 REMOVAL

1. Remove the suppressor from the rifle. See 4.0 *Removing Suppressor From Firearm* on page 23.

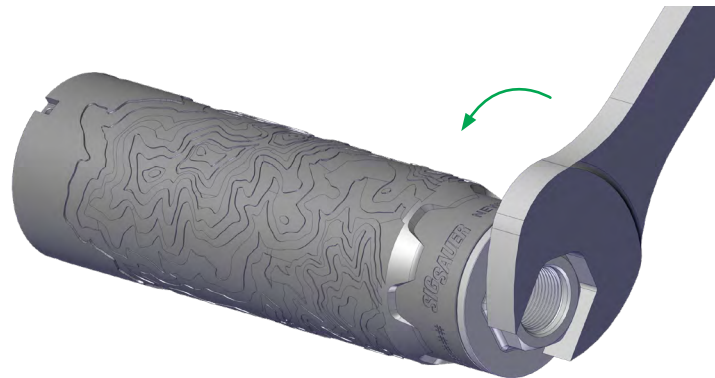

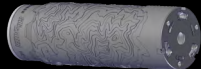

- Using a 7/8-in. wrench, remove the HUB tapered mount from the suppressor body.

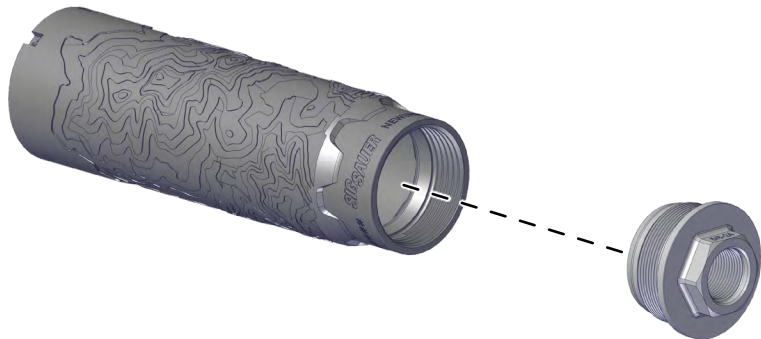

## CAUTION

FURTHER DISASSEMBLY OF THE SUPPRESSOR IS NOT AUTHORIZED. FAILURE TO COMPLY MAY DAMAGE SUPPRESSOR.

## 6.2 INSTALLATION

- Thread the preferred HUB tapered mount onto the suppressor.

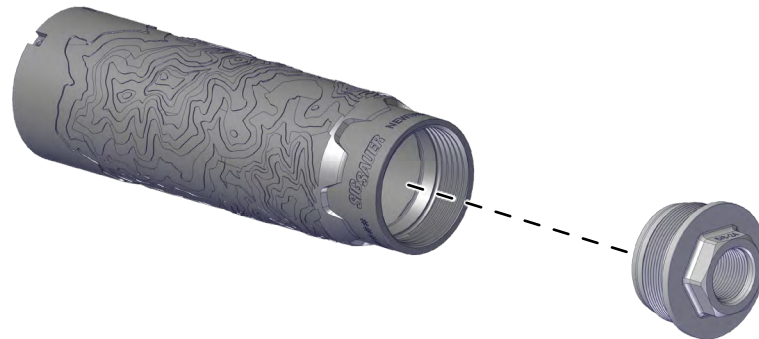

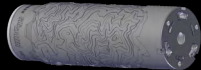

- Using a 7/8-in. crow's foot wrench and a torque wrench handle, torque the mount to 35 ft-lbf.

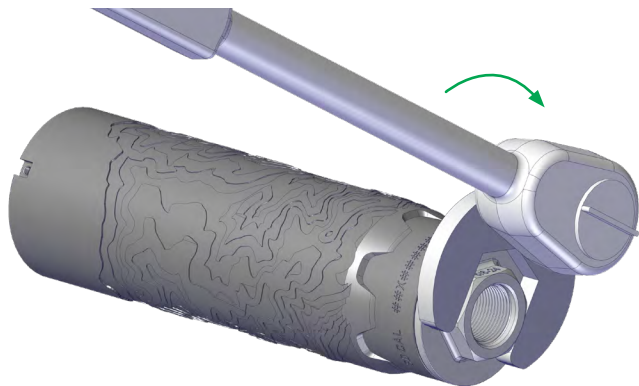
**SIG SAUER INFINITE GUARANTEE™**

For warranty information on new SIG SAUER firearms, scan the QR code below to visit the SIG SAUER Warranty Information and Registration page. New firearms can also be registered and warranty information can be found on the website.

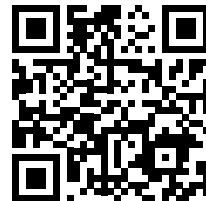

**SIG SAUER®**

**sigsauer.com**

**SIG SAUER, Inc.  
72 Pease Boulevard, Newington, NH 03801 USA**

All trademarks, service marks, trade names, trade dress, product names, and logos appearing in this manual are the property of their respective owners. No trademark or service mark appearing in this manual may be used without written consent of the mark's owner.